



## MBR2040CT Dual schottky barrier diodes

### QUICK REFERENCE DATA

VR = 40 V

IF(AV) = 20 A

VF ≤ 0.7V

### MECHANICAL DATA :

- Case: TO-252/251 molded plastic
- Polarity: As marked.
- Mounting Position: Any
- Weight: 0.0655 ounces, 1.859 grams
- Terminals: solder plated,  
solderable per MIL-STD-750, Method 2026

### SYMBOL :

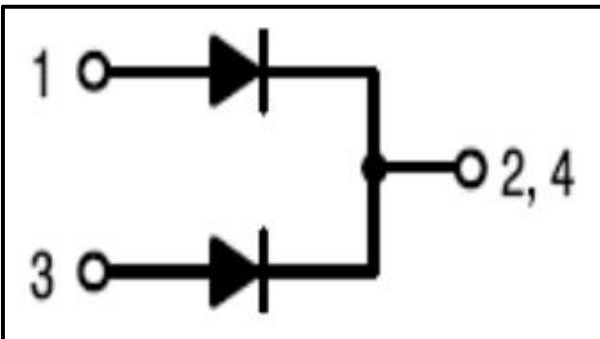

### FEATURES :

- Plastic package has Underwriters Laboratory Flammability Classification 94V-O Flame Retardant Epoxy Molding Compound
- Metal silicon junction, majority carrier conduction
- Low power loss, high efficiency
- High current capability
- Guardring for overvoltage protection
- In compliance with EU RoHS 2002/95/EC directives
- For use in low voltage, high frequency inverters free wheeling , and polarity protection applications.

### PINNING:

PIN	DESCRIPTION
1	anode 1
2	cathode 1
3	anode 2
tab	cathode

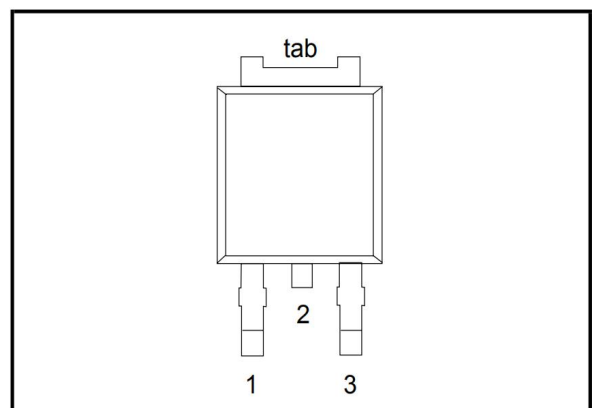



**MAXIMUM RATINGS AND ELECTRICAL CHARACTERISTICS**

Ratings at 25°C ambient temperature unless otherwise specified. Single phase, half wave, 60 Hz, resistive or inductive load. For capacitive load, derate current by 20%

Parameter	Symbol	Test Condition	MIN	TYP	Max	Unit
Peak Repetitive Reverse Voltage	VRRM				40	V
Maximum RMS Voltage	VRMS				28	V
Maximum DC Blocking Voltage	VR(DC)				40	V
Average Rectified Forward Current	IF(AV)				20	A
Peak Forward Surge Current: 8.3ms single half sine-wave superimposed on rated load (JEDEC method)	IFSM				200	A
Maximum Forward Voltage at 10A, per leg	VF				0.7	V
Maximum DC Reverse Current T=25°C	IR			0.05	0.1	mA
at Rated DC Blocking Voltage T=125°C					20	mA
Voltage Rate of Change (Rated VR)	dv/dt				10,000	v/μs
Typical Thermal Resistance	RθJC				2	°C/W
Operating junction temperature	Tj		-65		175	°C
Storage temperature	Tstg		-65		175	°C

**Notes :**

- Both Bonding and Chip structure are available.
- Pulse Test: Pulse Width = 300 ms, Duty Cycle ≤ 2.0%
- The heat generated must be less than the thermal conductivity from Junction-to-Ambient:  $dPD/dTJ < 1/RqJA$ .



TYPICAL ELECTRICAL AND THERMAL CHARACTERISTICS

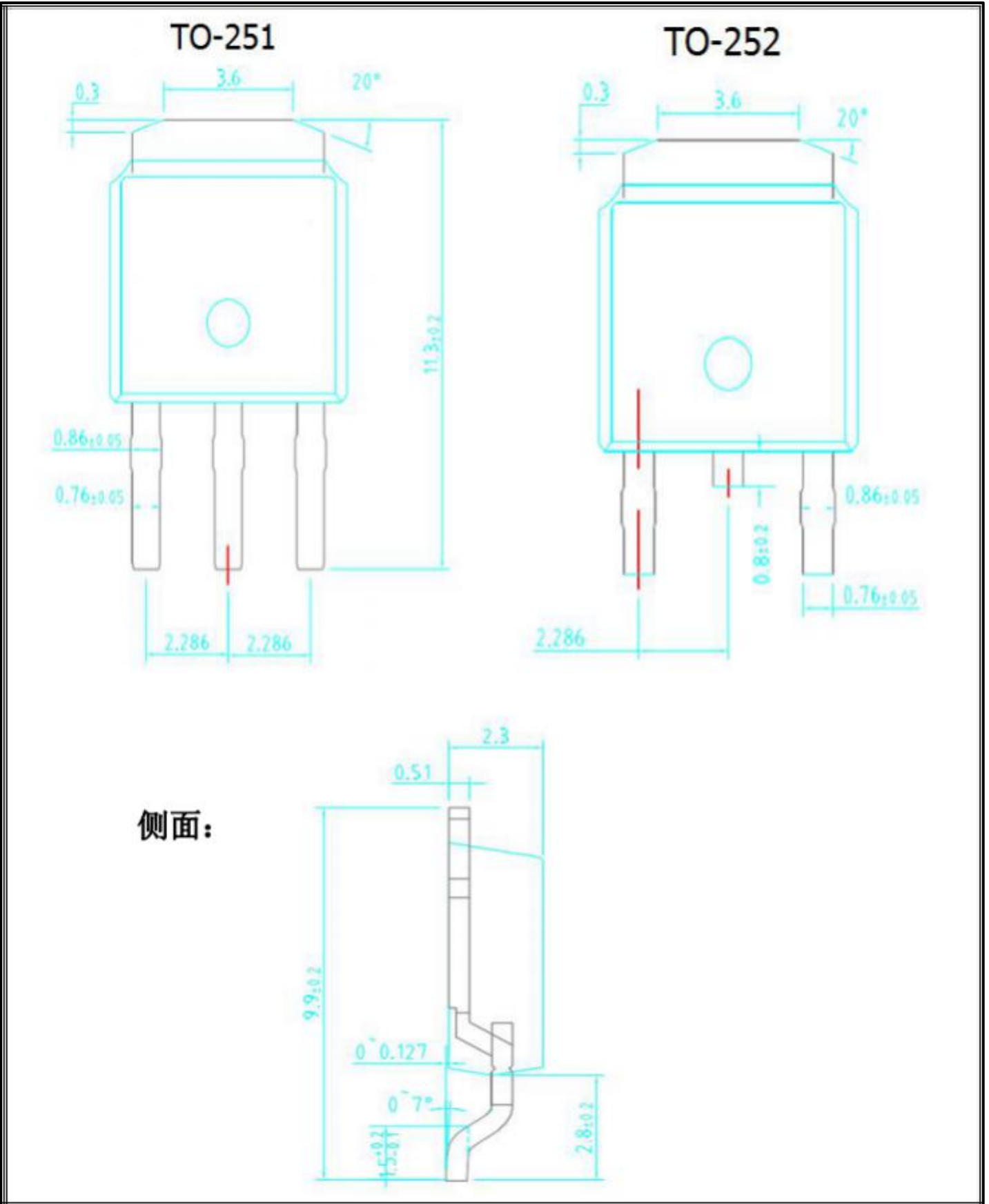



RATING AND CHARACTERISTIC CURVES

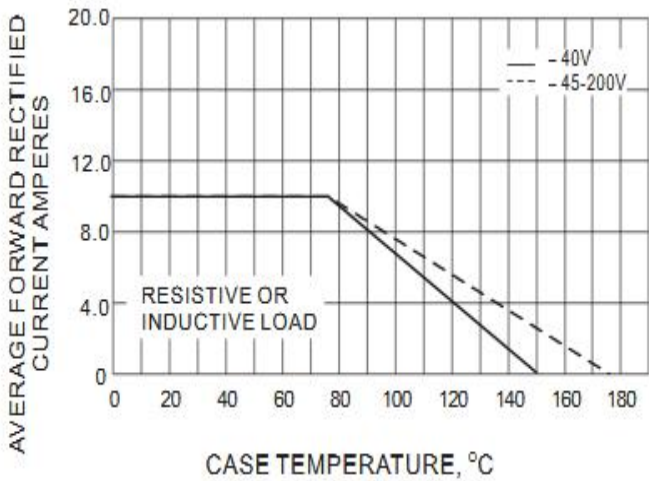

Fig.1- FORWARD CURRENT DERATING CURVE

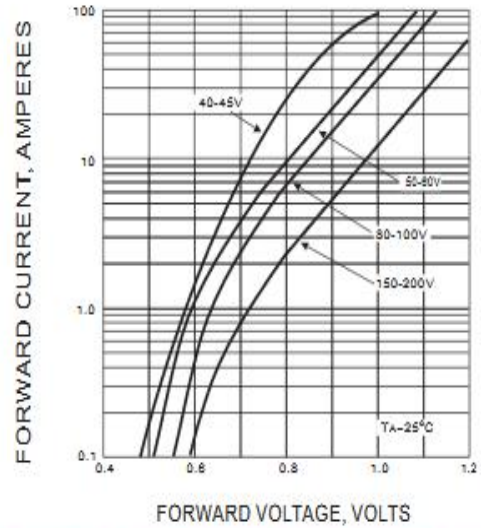

Fig.2- TYPICAL INSTANTANEOUS FORWARD CHARACTERISTIC

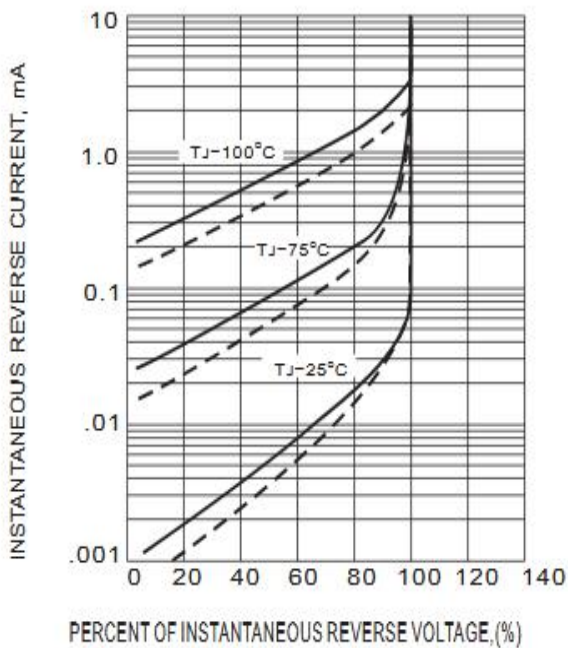

Fig.3- TYPICAL REVERSE CHARACTERISTICS

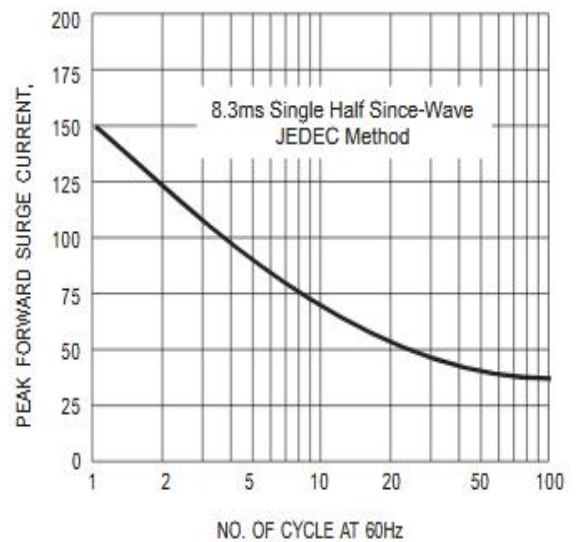

Fig.4- TYPICAL INSTANTANEOUS FORWARD CHARACTERISTICS